MD20xx Laser Barcode Scanner

User Manual



Version: MD20xx_UM_EN_V1.1.5

Notice



Ensure that the optional DC adapter works at +5V, especially for the RS-232 interface cable.

Make sure you carefully read the following information to ensure that your barcode scanner is able to perform at the designed level.

1. All software, including firmware, furnished to the user is on a licensed basis.
2. The right is reserved to make changes to any software or product to improve reliability, function, or design.
3. The material in this manual is subject to change without notice.
4. A standard packing includes a scanner, a USB cable and a CD (or a user manual). Accessories include a stand, a 5V adaptor and a RS-232 cable.
5. The Auto-detection is an optional accessory.
6. Different firmware version have the different functions, please make sure you get the right version.

Contents

Notice.....	i
Contents.....	iii
1 Specifications	1
1-1 Technical specifications	1
1-2 Default settings for various types of barcode	2
1-3 Decode zone	3
2 Get started	4
2-1 Electrical interface/Pin assignment	4
2-2 Dimensions	5
2-3 Parts of the scanner	6
2-4 Introduction to installation	7
2-4-1 Installation - RS-232	7
2-4-2 Installation - USB	7
2-4-3 Remove the interface cable	8
2-5 Assembling the stand	8
2-6 Scanning	9
2-7 Auto-detection	9
3 Parameter menus	11
3-1 Introduction	11
3-2 Example: configure scanner	12
3-3 RS232 interface	14
3-4 USB interface	17
3-5 Scan trigger mode & some global settings	20
3-6 Indication	26
3-7 UPC-A	28
3-8 UPC-E	30
3-9 UPC-E1	32
3-10 EAN-13 (ISBN/ISSN)	34
3-11 EAN-8	36
3-12 Code 39 (Code 32, Trioptic Code 39)	38
3-13 Interleaved 2 of 5	41
3-14 Industrial 2 of 5	43
3-15 Matrix 2 of 5	44
3-16 Codabar	46
3-17 Code 128	48
3-18 UCC/EAN 128 (GS1-128)	50
3-19 ISBT 128	52
3-20 Code 93	54

3-21 Code 11	56
3-22 MSI/Plessey	58
3-23 UK/Plessey	60
3-24 China Post	62
3-25 Telepen	63
3-26 GS1 DataBar (GS1 DataBar Truncated)	65
3-27 GS1 DataBar Limited	66
3-28 GS1 DataBar Expanded.....	67
3-29 G1-G4 & FN1 substitution string setting.....	68
3-30 G1-G4 string position & Code ID position	71
3-31 String transmission.....	72
4 Barcode representing non-printable character	74
5 ASCII table	75
6 Test chart	76
7 Return default parameters & firmware version	78
8 Quick setting to enable/ disable Auto-detection	79
9 Configuration alphanumeric value barcode (as Para. value)	80

1 Specifications

1-1 Technical specifications

Table 1-1 Technical specifications @25°C

Input voltage	5 VDC \pm 0.25 V
Power	150 mW (Standby); 525 mW (Operating); 850 mW (Max.)
Current	30 mA (Standby); 105 mA (Operating); 170 mA (Max.)
Laser	630-650 nm laser diode
Decoding rate	200 times/sec
Scanning angle	\pm 65°, \pm 70°, \pm 42° (Skew, Pitch, Roll)
Print contrast	25% minimum reflection difference
Decode capability	UPC-A, UPC-E, UPC-E1, EAN-13, EAN-8, ISBN (Bookland EAN), ISSN, Code 39, Code 39 full ASCII, Code 32, Trioptic Code 39, Interleaved 2 of 5, Industrial 2 of 5 (Discrete 2 of 5), Matrix 2 of 5, Codabar (NW7), Code 128, UCC/EAN 128 (GS1-128), ISBT 128, Code 93, Code 11 (USD-8), MSI/Plessey, UK/Plessey, China Post, Telepen, GS1 DataBar (formerly RSS) variants
Indicator	Beeper, LED
Interface supported	RS-232, USB Keyboard, USB virtual COM
Operating mode	Hand-held, Auto-detection (Optional accessory)
Dimensions	Height \times Width \times Depth: 76 mm \times 66.5 mm \times 168 mm
Weight	121 g, without cable
Cable	Straight 2.0 m
Connector type	RJ-45 phone jack connector
Case material	ABS
Exit window material	PC
Temperature	0° to 50°C (32° to 122°F), Operating; -40° to 60°C (-40° to 140°F), Storage
Humidity	5% to 95% (non-condensing)
Programming method	Manual (reading special barcode)
Program upgrade	Online
Decoding depth & Min. element width	(1 mil = 0.0254 mm) 3 mil: 27 - 65 mm 4 mil: 27 - 60 mm 5 mil: 18 - 132 mm 10 mil: 10 - 320 mm 13 mil: 16 - 380 mm 15 mil: 13 - 500 mm 20 mil: 19 - 620 mm 30 mil: 25 - 770 mm
Safety	Laser safety: EN60825-1, Class 1 EMC: EN55022, EN55024 Electrical safety: EN60950-1 Drop resistance: 30+ times 2.0 m (6.5 ft) drops to concrete Protection class: IP50

1-2 Default settings for various types of barcode

Table 1-2 Default settings

Code type	Read enable	Check digit verification	Check digit transmission	Min. code length	Proprietary code ID	AIM code ID
UPC-A	√	√	√	(12) ²	A]Em
UPC-E	√	√	√	(8) ²	D]Em
UPC-E1	√	√	√	(8) ²	D]Em
EAN-13	√	√	√	(13) ²	A]Em
EAN-8	√	√	√	(8) ²	C]Em
ISBN/ISSN ¹	√	√	√	(13) ²	B]Em
Code 39	√	-	-	1	M]Am
Interleaved 2 of 5	√	-	-	6	I]Im
Industrial 2 of 5 (Discrete 2 of 5)	-	-	-	4	H]Im
Matrix 2 of 5	√	-	-	6	X]Im
Codabar (NW7)	√	-	-	4	N]Fm
Code 128	√	√	-	1	K]Cm
UCC/EAN 128	√	√	-	1	K]Cm
ISBT 128	√	√	-	1	K]Cm
Code 93	√	√	-	1	L]Gm
Code 11 (USD-8)	-	√	-	4	V	-
MSI/Plessey	-	-	-	4	O]Mm
UK/Plessey	√	√	-	1	U]Mm
China Post	√	-	-	(11) ²	T]Im
Telepen	√	√	-	1	P]Em
GS1 DataBar	√	-	-	(16) ²	R]em
GS1 DataBar Truncated ³	√	-	-	(16) ²	R]em
GS1 DataBar Limited	√	-	-	(16) ²	R]em
GS1 DataBar Expanded	√	-	-	1	R]em

Note: ¹The settings for ISBN/ISSN and EAN-13 must be the same except the code ID.

² Fixed-length barcodes.

³The settings for GS1 DataBar Truncated and GS1 DataBar must be the same.

1-3 Decode zone

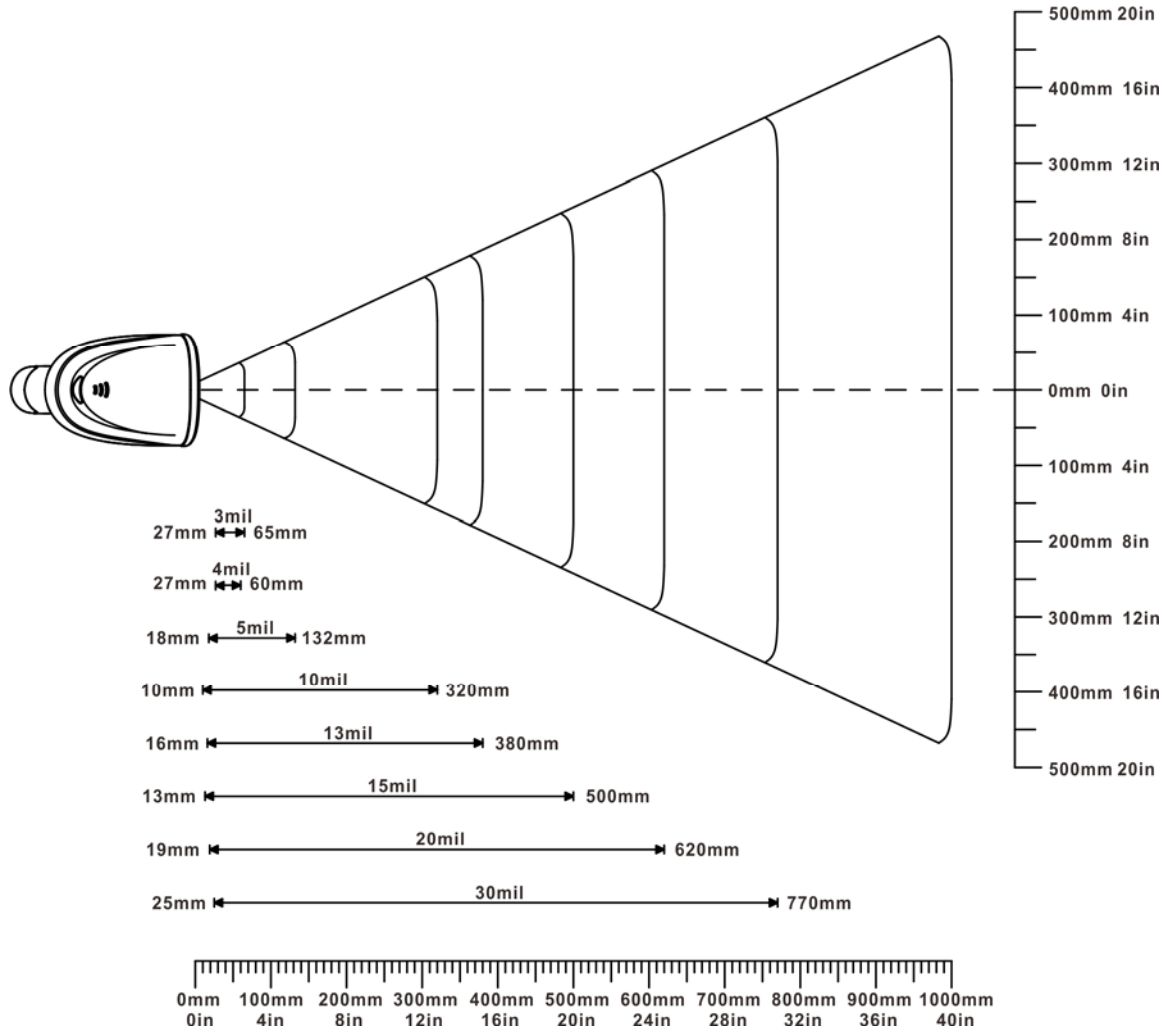

Figure 1-1 Decode zone @25°C, scan angle: 55°

Table 1-3 Description of barcode patterns applied in Figure 1-1

Resolution	Barcode type	Wide-narrow element ratio	Barcode content	Contrast
3 mil	Code39	2.5 : 1	123	80%
4 mil	Code39	2.5 : 1	123456789	80%
5 mil	Code39	2.5 : 1	123	80%
10 mil	Code39	2.5 : 1	123	80%
13 mil	100%UPC	-	123456	80%
15 mil	Code39	2.5 : 1	1	80%
20 mil	Code39	2.5 : 1	1	80%
30 mil	Code39	2.5 : 1	EF	80%

2 Get started

2-1 Electrical interface/Pin assignment

The scanner provides a RJ-45 cable connector.

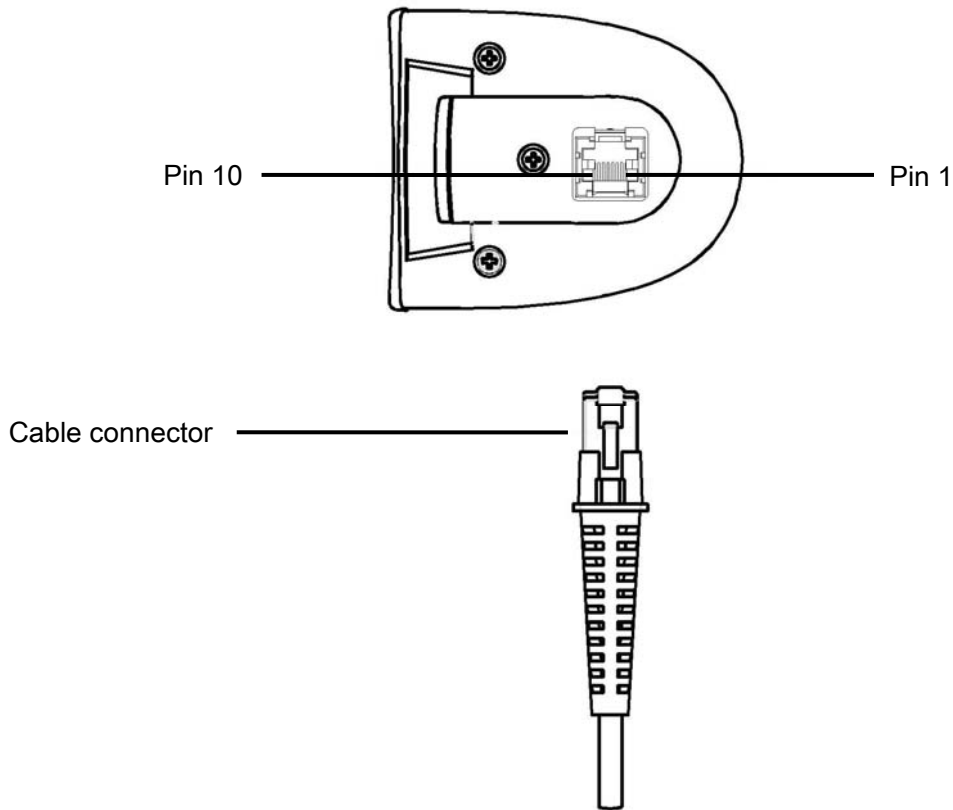

Figure 2-1 Electrical interface/Pin

Table 2-1 lists the pin assignments of the scanner.

Table 2-1 Electrical interface/Pin assignment

Pin	RS232 cable	USB cable
1	Power(+5V)	Power(+5V)
2	Reserved	Reserved
3	Ground	Ground
4	+3.3V (for interface auto selection purpose)	Ground (for interface auto selection purpose)
5	TxD	Reserved
6	RxD	Reserved
7	Ground (Shell)	Ground (Shell)
8	TRIGGER	TRIGGER
9	CTS	D-
10	RTS	D+

Note: Voltage level of all RS232 Pin-outs (RXD, TXD, CTS and RTS) is 0V for logic low level and 3.3V for logic high level. A transceiver (max232) PCB is designed inside the RS232 cable, and it can achieve signal transition between TTL and RS232.

2-2 Dimensions

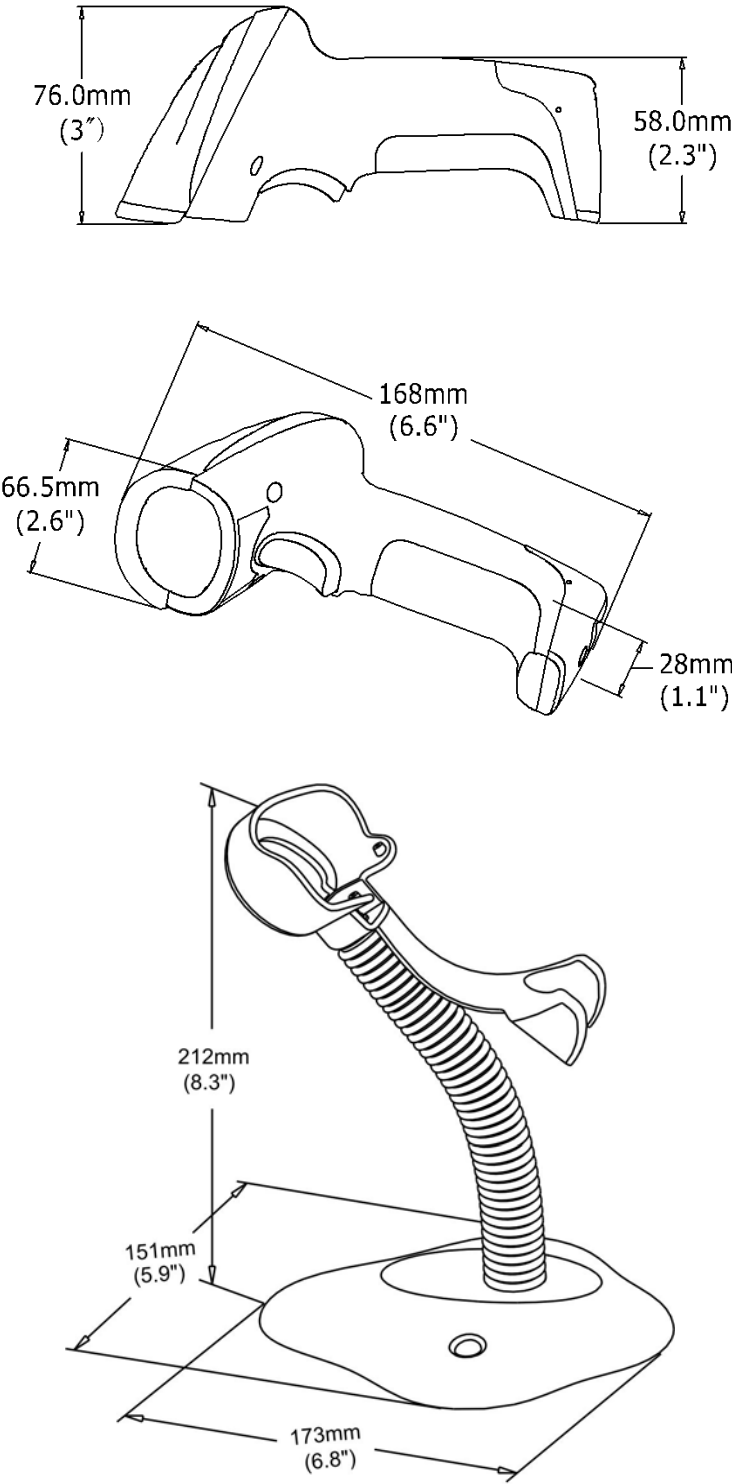

Figure 2-2 Dimensions

2-3 Parts of the scanner

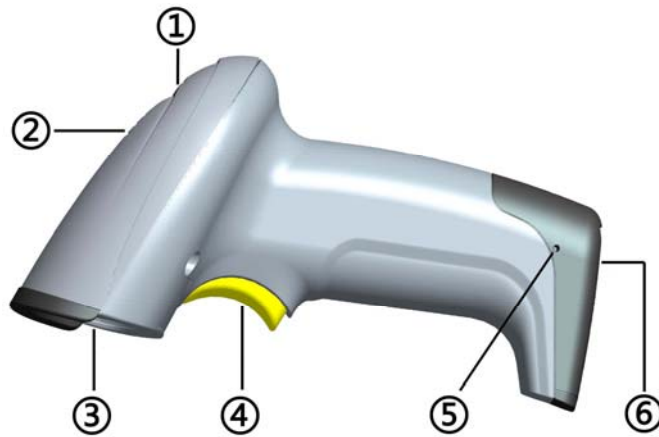

Figure 2-3 Parts of the scanner

- ① LED
- ② Beeper
- ③ Exit window
- ④ Trigger
- ⑤ Release-hole of the cable
- ⑥ Cable interface port

2-4 Introduction to installation

Note: If any of the below operation is incorrect, turn off the power immediately and check the scanner for any improper connections. Go through all steps again.

2-4-1 Installation - RS-232

1. Connect the RS-232 interface cable to the bottom of the scanner.
2. Connect the other end of the interface cable to the serial port on the host. Tighten the two screws to secure the connector to the port.
3. If the host does not have power supply (on PIN 9), connect the external power supply (DC 5V adapter) to the RS-232 cable.

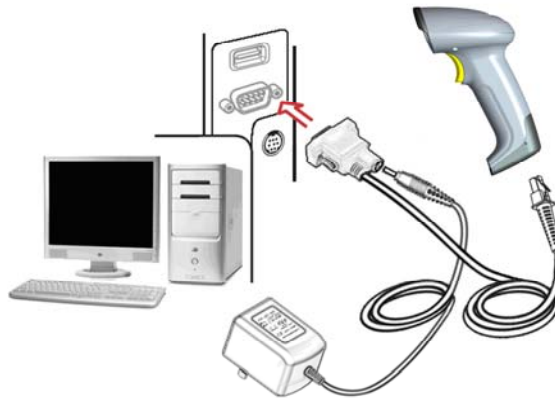

Figure 2-4 Installation - RS-232

2-4-2 Installation - USB

The scanner attaches directly to a USB host, and is powered by it. No additional power supply is required.

1. Refer to Figure 2-5, connect the USB interface cable to the bottom of the scanner.
2. Plug the series A connector in the USB host, or an available port of the terminal.
3. Windows will automatically detect the USB device.

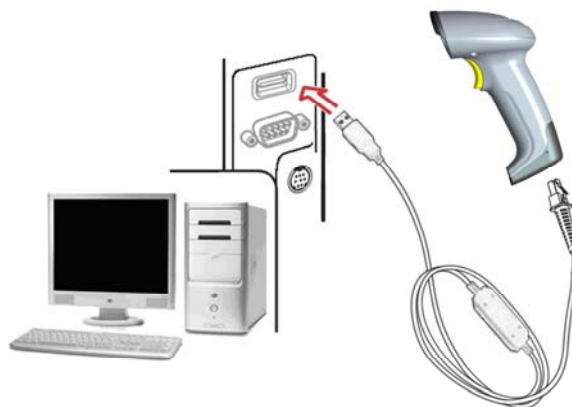

Figure 2-5 Installation - USB

2-4-3 Remove the interface cable



Figure 2-6

1. Find the release-hole.
2. Insert a thin wire into the hole and pull out the cable gently.

2-5 Assembling the stand

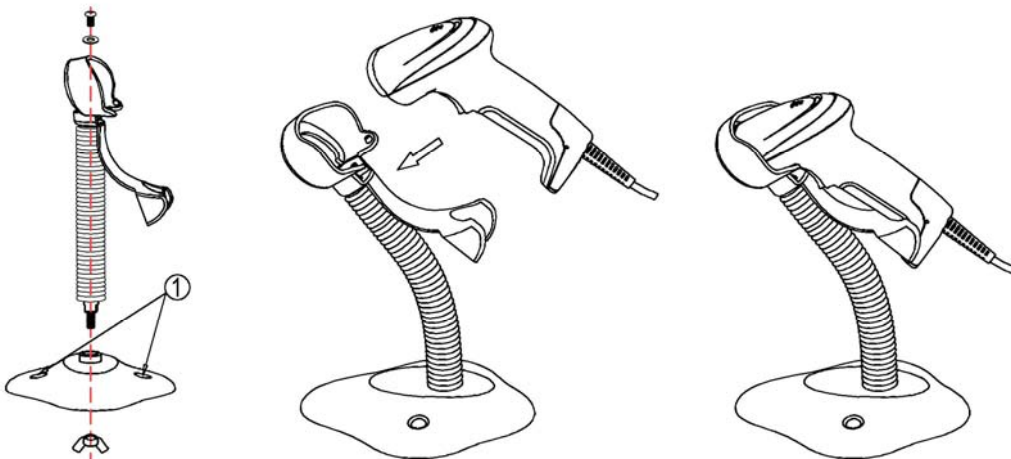

Note: The stand is an optional accessory.

1. See the figure above, tighten the screws.
2. Bend the neck to the desired position for scanning.
3. Screw mounting: Screw one #10 wood screw into each screw-mount-hole until the base of the stand is secured.
4. Tape mounting: ①Peel the paper liner off one side of each piece of tape and place the sticky surface over each of the three rectangular tape holders. ②Peel the paper liner off the exposed sides of each piece of tape and press the stand on a flat surface until it is secure.

2-6 Scanning

When the scanner is scanning, ensure the laser beam crosses every bar and space of the barcode. See Figure 2-7.



Figure 2-7

2-7 Auto-detection

Note: Auto-detection and stand are optional accessories.

1. To scan a barcode, present the bar code and ensure the scan line crosses every bar and space of the symbol.
2. Upon successful decode, the scanner beeps and the LED lights.
3. When the laser light is off, the present bar code must be removed to active next scanning.



Figure 2-8

The scanner offers 2 methods to enable/ disable Auto-detection quickly.

Method 1	Scan the barcode “EN-AutoDete” on the stand to enable Auto-detection. Scan the barcode “DIS-AutoDete” on the stand to disable Auto-detection. Note: The Scanning mode will switch to momentary. See Figure 2-9.
Method 2	Scan the barcode “%%SWAM” to enable Auto-detection. Scan the barcode “%%SWLM” to disable Auto-detection. Note: The Scanning mode will switch to momentary. See 8 Quick setting to enable/ disable Auto-detection .

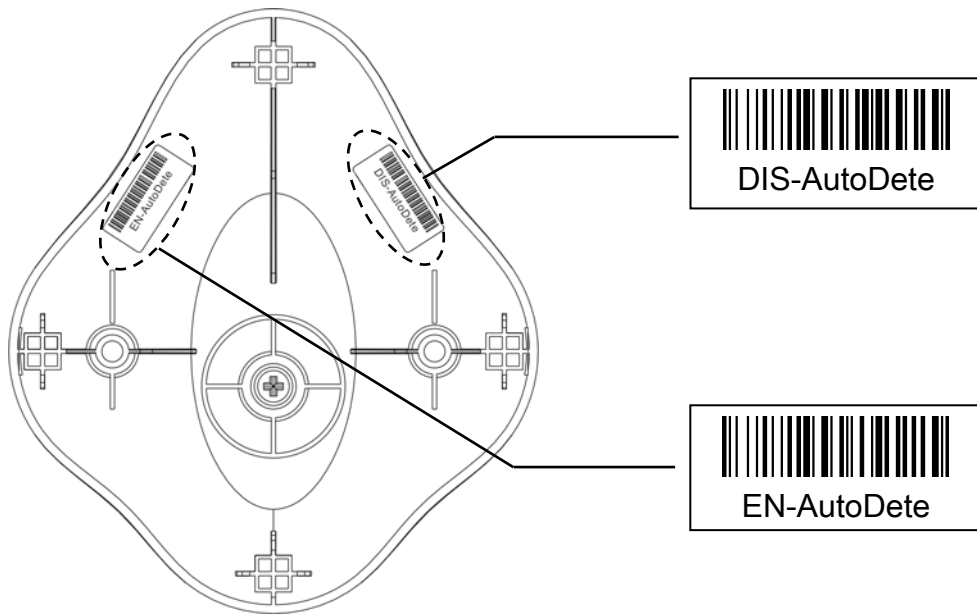

Figure 2-9

3 Parameter menus

3-1 Introduction

This section describes the programmable parameters, provides barcodes for programming.

The scanner is shipped with the factory default settings as described in this chapter. These factory-default-settings values are stored in flash memory and are preserved even when the scanner is powered down. Changes to the factory default values can be stored as custom defaults. These values are also stored in flash memory and are preserved even when the scanner is powered down.

There are two methods to change the parameter values as described following.

- ✚ Scan the appropriate barcodes as the example shown in *3-2 Example: configure scanner*. The new values replace the existing memory values.
- ✚ Referring to *7 Return default parameters & firmware version*, scan the **Write to customer's default setting** (%%WCDF) barcode to set the new values as custom defaults. The factory default or custom default parameter values can be recalled by scanning the **manufacture default setting** (%%DEF) barcode, or the **Restore customer's default setting** (%%RSDF) barcode.

3-2 Example: configure scanner

Note: The factory default settings are indicated with asterisks (*) in this manual.

1. Single-scan setting

Scan the appropriate Single-scan setting barcode according to the user's demand.

Example: Set Flow control to be none.

Steps: Scan the following barcode.



2. Multiple-scan setting

The steps of configuration are:

- a) Scan the SETUP barcode on the parameter setting part.
- b) Enter the option mode by scanning the Parameter name barcode.
- c) To the right of the option barcode, the necessary alphanumeric inputs are listed. Scan these alphanumeric entries (see [9 Configuration alphanumeric value barcode](#)) individually as Para.
Value.
- d) Scan the END barcode, listed on the bottom of each parameter setting part.

Notes that only one parameter can be setup at each time.

Example: Set Flow control to be none.

Steps: Scan the following barcodes in order.



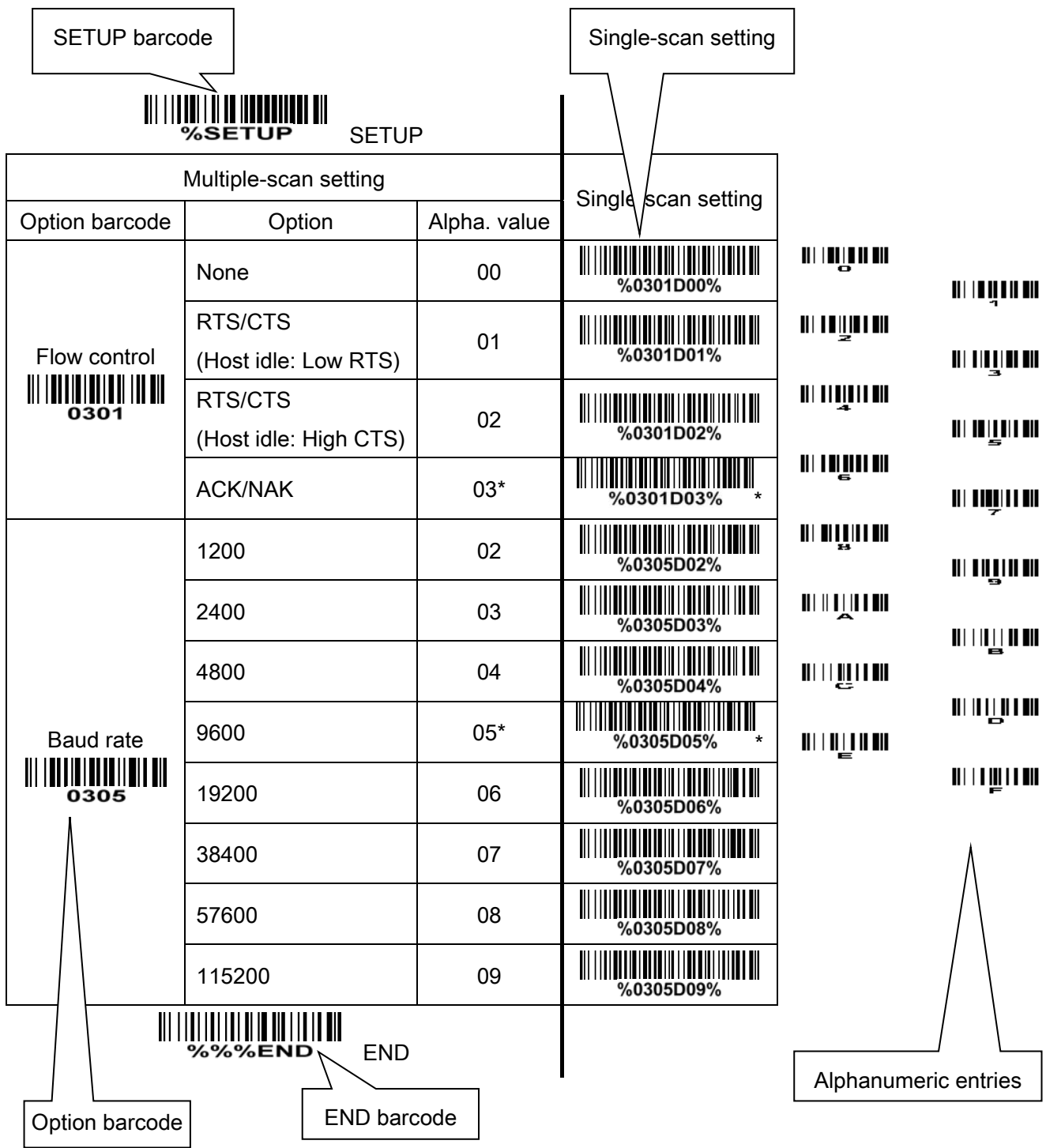

Figure 4-4

3-3 RS232 interface

Flow control:

None- The communication only uses TXD and RXD signals without any hardware or software handshaking protocol.

RTS/CTS- If the scanner requests to send the barcode data to host computer, it will issue the RTS signal first, wait for the CTS signal from the host computer, and then perform the normal data communication. If there is no replied CTS signal from the host computer after the **Response delay** timeout, the scanner will issue an error indication. By setting (Host idle: Low RTS or Host idle: High RTS), the scanner can be set to match the Serial Host RTS line.

ACK/NAK- If **Decode data packet format** is set to **Packeted**, after barcode data transmitted, the scanner expects either an ACK (acknowledge) or NAK (not acknowledge) response from the host. When a NAK is received, the scanner transmits the same data again and waits for either an ACK or NAK. After three unsuccessful attempts to send data when NAK are received, the scanner issues an error indication and discards the data. When the scanner finishes receiving the command from host, it will send ACK/NAK to host.

Note: If **Decode data packet format** is set to **Raw**, the scanner will not wait for ACK/NAK after transmitting decoded data completely.

Response delay: This delay is the time that the scanner waits for a handshaking acknowledgment (NAK or ACK) from the host.

Inter-character delay: This delay is the time that the scanner transfer the each character interval.

Host-character delay: This delay is the time that the scanner waits for the host to send the next character in serial communication.

Decoded data packet format:

Raw- Scanner sends raw decoded data directly.

Packeted- The decoded data is sent in data packet.



%SETUP

SETUP

Multiple-scan setting			Single-scan setting
Option barcode	Option	Alpha. value	
Flow control 0301	None	00	 %0301D00%
	RTS/CTS (Host idle: Low RTS)	01	 %0301D01%
	RTS/CTS (Host idle: High RTS)	02	 %0301D02%
	ACK/NAK	03*	 %0301D03% *
Inter-character delay 0302	00-99 (1ms)	00-99	
		00*	 %0302D00% *
Response delay 0304	01-99 (100 ms)	01-99	
		20*	 %0304D20% *
Baud rate 0305	1200	02	 %0305D02%
	2400	03	 %0305D03%
	4800	04	 %0305D04%
	9600	05*	 %0305D05% *
	19200	06	 %0305D06%
	38400	07	 %0305D07%
	57600	08	 %0305D08%
	115200	09	 %0305D09%
Parity 0306	None	00*	 %0306D00% *
	Odd	01	 %0306D01%



%SETUP

SETUP

Multiple-scan setting			Single-scan setting
Option barcode	Option	Alpha. value	
	Even	02	 %0306D02%
Data bit 0307	8 bits	00*	 %0307D00% *
Stop bit 0308	1 bit	00*	 %0308D00% *
	2 bits	01	 %0308D01%
Host-character delay 0309	01-99 (10ms)	01-99	
		20*	 %0309D20% *
Decoded data packet format 0310	Raw	00*	 %0310D00% *
	Packeted	01	 %0310D01%



%%%END

END

3-4 USB interface

USB device type:

HID keyboard– By setting, the scanner is used as a USB HID keyboard emulation device.

USB virtual COM– By setting, the scanner emulates a USB virtual COM device. If a Microsoft Windows PC is connected to the scanner, a driver is required to install on the connected PC. The driver will use the next available COM Port number. The driver and the installation guide can be found in the associated CD and on the manufacturer's website. A Windows-based software COM_Text is recommended to display the barcode data in text format. COM_Text emulates some kind of serial-key typing.

While emulating as a USB virtual COM, the scanner will send the data in data packet format if the Decode data packet format is **Packeted** (see [3-3 RS232 Interface](#)). The scanner also follows the Flow control (see [3-3 RS232 Interface](#)) flow control, if it is set **ACK/NAK**.

Note: After changing USB Device Types, the scanner will restart automatically.

Keyboard layout: The scanner supports different national keyboard layouts.

Inter-character delay: This delay is inserted after each data character transmitted.

Numeric key:

Alphabetic key- The scanner will output code result as alphabetic key.





















Numeric key- The scanner will output code result as pressing numeric keypad ('0', '1', '2', '3', '4', '5', '6', '7', '8', '9', '.', '+', '-', '/', '*' only).

Alt + keypad- The scanner will output code result as pressing Alt+ numeric key (on keypad). Note that the Num Lock control key must be ON. This setting can be specially adapted for use with different national keyboard layout.



%SETUP

SETUP

Multiple-scan setting			Single-scan setting
Option barcode	Option	Alpha. value	
USB device type  0901	HID keyboard	00*	 %0901D00% *
	HID keyboard for Apple Mac	01	 %0901D01%
	USB virtual COM	02	 %0901D02%
Keyboard layout  0902	USA	00*	 %0902D00% *
	Turkish F	01	 %0902D01%
	Turkish Q	02	 %0902D02%
	French	03	 %0902D03%
	Italian	04	 %0902D04%
	Spanish	05	 %0902D05%
	Slovak	06	 %0902D06%
	Denmark	07	 %0902D07%
	Japanese	08	 %0902D08%
	German	09	 %0902D09%
	Belgian	10	 %0902D10%
	Russian	11	 %0902D11%
Inter-character delay  0903	0 ms	00	 %0903D00%
	5 ms	01*	 %0903D01% *
	10 ms	02	 %0903D02%



%SETUP SETUP

Multiple-scan setting			Single-scan setting
Option barcode	Option	Alpha. value	
	20 ms	03	 %0903D03%
	40 ms	04	 %0903D04%
	60 ms	05	 %0903D05%
Numeric key 0904	Alphabetic key	00*	 %0904D00% *
	Numeric keypad	01	 %0904D01%
	Alt + keypad	02	 %0904D02%



%%END END

3-5 Scan trigger mode & some global settings

Scanning mode:

Good-read off-The trigger button must be pressed once to activate scanning. The light source of scanner stops scanning when there is a successful reading or no code is decoded after the **Stand-by duration** elapsed.

Momentary-The trigger button acts as a switch. Press button to activate scanning and release button to stop scanning. The light source of scanner stops scanning when there is a successful reading or no code is decoded after the **Stand-by duration** elapsed.

Alternate continue-The trigger button acts as a toggle switch. Press button to activate or stop scanning.

Continue-The scanner always keeps scanning, and it does not matter when the trigger button is pressed or duration is elapsed.

Timeout off-The trigger button must be pressed once to activate scanning. The light source of scanner stops scanning when no code is successful decoded after the **Stand-by duration** elapsed.

Auto-detection- By setting Enable, the scanner will start operating if any nearby object has been detected. The laser light of scanner stops scanning when there is a successful reading or no code is decoded after the **Stand-by duration** elapsed. Once the laser light stops scanning, the present object must be removed to enable **Auto-detection**.

Note: Restoring the default settings by the host command or scanning the barcode that will not affect the scanning mode settings.

Standby duration: The duration time for a single scanning attempt.

Same barcode delay time: If a barcode has been scanned and output once successfully, the laser beam must be off or moved away from the barcode beyond delay time to active next scanning the same barcode. When this feature is set to be "0xFF", then the delay time is indefinite.

Multiple confirm: If this parameter is set to be larger than zero, the scanner will require several successful reads of same-decoded-data to confirm a valid reading. The number of successful reads can be different according to different types of barcode. As the number of Multiple confirm gets larger, the scanner's aggressiveness decreases. The number of successful reads required for different types of barcode is listed below, which is related to the parameter of Multiple confirm.

Table 4-1 The number of successful reads (n)

Barcode type	Multiple confirm (m)			
	m=0	m=1	m=2	m>=3
EAN-13, EAN-8, UPC-A, Code93, China Post, UK Plessey	n=2	n=3	n=4	n=m+1
UPC-E, Codabar, Interleaved 2/5, Code39, Industry2/5, Matrix 2/5, Code11, MSI Plessey, UPC-E1	n=3	n=4	n=4	n=m+1
UCC/EAN128, Code128, GS1 DataBar, GS1 DataBar Limited, GS1 DataBar Expand, ISBT 128	n=1	n=2	n=3	n=m+1

Global Max./Min. code length: These two lengths are defined as the valid range of decoded barcode data length. Make sure that the minimum length setting is no greater than the maximum length setting, otherwise the labels of the symbol will not be readable. In particular, the same value can be set for both minimum and maximum reading length to force the fixed length barcode decoded.

Notes:

1. Please set the max./min. length for individual barcode in later sections, if special demand is requested.
2. The number of check digits is included in max./min. code length.
3. These two settings have no effect on the symbols with fixed-length, e.g. UPC-A, UPC-E, EAN-13, EAN-8 and China Post.

Global G1-G4 string selection: The scanner offer one or two string group for all symbols. By setting one or two digits to indicate which string group you want to apply. You may refer to [3-29 G1-G4 & FN1 substitution string setting](#) and [3-30 G1-G4 string position & Code ID position](#).

Example: Group 1 → set 01 or 10. Group 2 and 4 → set 24 or 42.

All valid settings include 00, 01, 02, 03, 04, 10, 11, 12, 13, 14, 20, 21, 22, 23, 24, 30, 31, 32, 33, 34, 40, 41, 42, 43, and 44.

Setting value	Description
00	None
01、 10、 11	Only insert Group 1
02、 20、 22	Only insert Group 2
03、 30、 33	Only insert Group 3
04、 40、 44	Only insert Group 4
12、 21	Insert Group 1 first, then insert Group 2
13、 31	Insert Group 1 first, then insert Group 3
14、 41	Insert Group 1 first, then insert Group 4
23、 32	Insert Group 2 first, then insert Group 3
24、 42	Insert Group 2 first, then insert Group 4
34、 43	Insert Group 3 first, then insert Group 4

Element amendment: If it is enabled, the scanner can read the barcode comprised with bars and spaces in different scale.

Character output restraint:

Disable- the scanner will output all the barcode data .

Printable character only- If this option is selected, the scanner will output the printable characters only, i.e. in ASCII from 20H to 7EH.

Alphanumeric character only- If this option is selected, the scanner will output the alphanumeric characters only, i.e. "A"-“Z”, "a"-“z”, "0"-“9”.

Decoder optimization: If it is enabled, the scanner will optimize the decoder with error correction. This function is not effective for all types of barcodes.

Scan angle: If narrow angle (40°) is selected, the decode rate is 1 time/scan; if wide angle (55°) is selected, the decode rate is 0.5 time/scan.

Auto-sleep delay: After responding to the host's requirement, the scanner will automatically enter deep sleep state within Auto-sleep delay time. The scanner will be awakened while the SCAN button is pressed or a command WAKEUP (0x00) is received again.

"No read" response: If it is enabled, while the scanner receives the STOP_DECODE command or fails to decode a barcode within the Stand-by duration time, "NR" will be transmitted as decode data.

Deep sleep:

Disable- When Stand-by duration is elapsed, the scanner will enters normal **sleep state**. Any external interrupt can wake up the scanner. It is not necessary to send a command WAKEUP (0x00) before sending any other commands.



















Enable- When Stand-by duration is elapsed, the scanner will enters sleep state deeply, and the supply current will drop to be 0.9mA. And at this case, it is necessary to send a command WAKEUP (0x00) and delay for 15ms, before sending any other commands.

Character encoding system: A character encoding system consists of a code that pairs each character from a given repertoire. Common examples include Morse code, the Baudot code, the ASCII and Unicode. If the data received does not display with the proper characters, it may be because the barcode being scanned was created using a character encoding system that is different from the one the host program is expecting. Try alternate options to find the proper one.



%SETUP

SETUP

Multiple-scan setting			Single-scan setting
Option barcode	Option	Alpha. value	
Scanning mode ^{Note 1}  0401	Good-read off	00	 %0401D00%
	Momentary	01*	 %0401D01% *
	Alternate continue	02	 %0401D02%
	Continue	03	 %0401D03%
	Timeout off	04	 %0401D04%
	Auto-detection	03	 %0401D05%
Standby duration  0402	01-99 (100ms)	01-99	
		40*	 %0402D40% *
Same barcode delay time  0403	00-FF ₁₆ (100ms) (00: None)	00-FF ₁₆	
		00	 %0403H00%
		0A*	 %0403H0A% *
Double confirm  0404	00-09 (00: None)	00-09	
		00*	 %0404D00% *
Global max. code length  0405	04-99	04-99	
		99*	 %0405D99% *
Global min. code length  0406	01-99	01-99	
		04*	 %0406D04% *
Global G1-G4 string selection	00-44	00-44	



%SETUP

SETUP

Multiple-scan setting			Single-scan setting
Option barcode	Option	Alpha. value	
 0407	(00: None)	00*	 *%0407D00%*
Element amendment 0408	Disable	00	 %0408D00%
	Enable	01*	 *%0408D01%*
Character output restraint 0409	Disable	00*	 *%0409D00%*
	Printable character only	01	 %0409D01%
	Alphabetic & Numeric only	02	 %0409D02%
Decoder optimization 0410	Disable	00	 %0410D00%
	Enable	01*	 *%0410D01%*
Scan angle 0411	Wide (56°)	00*	 *%0411D00%*
	Narrow (40°)	01	 %0411D01%
Auto-sleep delay ^{Note 2} 0412	1 second	00	 %0412D00%
	5 seconds	01	 %0412D01%
	10 seconds	02	 %0412D02%
	30 seconds	03*	 *%0412D03%*
	1 minute	04	 %0412D04%
	3 minutes	05	 %0412D05%
	10 minutes	06	 %0412D06%
30 minutes	07	 %0412D07%	



%SETUP

SETUP

Multiple-scan setting			Single-scan setting
Option barcode	Option	Alpha. value	
	1 hour	08	 %0412D08%
	3 hours	09	 %0412D09%
	Never	10	 %0412D10%
“No read” response 0413	Disable	00*	 %0413D00% *
	Enable	01	 %0413D01%
Deep sleep 0414	Disable	00*	 %0414D00% *
	Enable	01	 %0414D01%
Character encoding system 0415	ASCII	00*	 %0415D00% *
	UTF-8	01	 %0415D01%
	Windows-1251	02	 %0415D02%



%%END

END

Note 1: This configure will not be changed when the scanner scans load default setting barcode.

Note 2: The tolerance is ±20%.

3-6 Indication

Power on alert: After power-on or restart, the scanner will generate alert signal (Beeper beeping and LED flashing).

LED indication: When the scanner decodes successfully, the LED will glitter.

Beeper indication: After each successful reading, the scanner will beep to indicate a good barcode reading, and its beep tone duration is adjustable.

Beep tone duration: This parameter can be adjusted for a good reading upon favorite usage.

Volume of beeper: This parameter can be adjusted for different level of the volume of the beeper.

Frequency of beeper: This parameter can be adjusted for different level of the frequency of the beeper.



%SETUP

SETUP

Multiple-scan setting			Single-scan setting
Option barcode	Option	Alpha. value	
Power on alert 0501	Disable	00	 %0501D00%
	Enable	01*	 %0501D01% *
LED indication 0502	Disable	00	 %0502D00%
	Enable	01*	 %0502D01% *
Beeper indication 0503	Disable	00	 %0503D00%
	Enable	01*	 %0503D01% *
Beep tone duration 0504	01-09 (25 ms)	01-09	
		03*	 %0504D03% *
Volume of beeper 0505	Low	00	 %0505D00%
	Middle	01	 %0505D01%
	High	02*	 %0505D02% *
Frequency of beeper 0506	2.7KHz	00*	 %0506D00% *
	2.5KHz	01	 %0506D01%
	2.3KHz	02	 %0506D02%



%%%END

END

3-7 UPC-A

Read:

Format

System character	Data digits (10 digits)	Check digit
------------------	-------------------------	-------------

Check digit verification: The check digit verification is optional.

Check digit trans.: By setting Enable, check digit will be transmitted.

Code ID setting: Code ID is a one-or-two-character string used to represent the symbol upon a succeeding reading. If you want application to transmit Code ID, you must set **Code ID transmission** to be enabled. Refer to [3-31 String transmission](#).

Insert group selection: Refer to **Global G1-G4 string selection** of [3-5 Scan trigger mode & some global settings](#).

Supplement digits: The Supplement digits barcode is the supplemental 2 or 5 characters.

Format

System character	Data digits (10 digits)	Check digit	Supplement digits 2 or 5
------------------	-------------------------	-------------	--------------------------

Truncation/Expansion:







Truncate leading zeros- The leading “0” digits of UPC-A data characters can be truncated when the feature is enabled.

Expand to EAN-13- It extends to 13-digits with a “0” leading digit when the feature is enabled.

Truncate system character- The system character of UPC-A data can be truncated when the feature is enabled.

Add country code- The country code (“0” for USA) can be added when the feature is enabled.

Ink Spreading Canceling: If enabled, the scanner can more easily read the UPC-A barcode printed with ink spreading. But it may cause the scanner to decode some well-printed UPC-A barcode wrongly. Please ask the advice from the support engineer of the manufacturer before applying this function.

 %SETUP SETUP			
Multiple-scan setting			Single-scan setting
Option barcode	Option	Alpha. value	
Read  1101	Disable	00	 %1101D00%
	Enable	01*	 %1101D01%*
Check digit verification  1102	Disable	00	 %1102D00%
	Enable	01*	 %1102D01%*



%SETUP SETUP

Multiple-scan setting			Single-scan setting
Option barcode	Option	Alpha. value	
Check digit trans. 1103	Disable	00	 %1103D00%
	Enable	01*	 %1103D01% *
Code ID setting 1104	00-FF ₁₆ (ASCII)	00-FF ₁₆	
		<A>*	 %1104H41% *
Insert group selection 1105	00-44 (00: None)	00-44	
		00*	 %1105D00% *
Supplement digits 1106	None	00*	 %1106D00% *
	2 digits	01	 %1106D01%
	5 digits	02	 %1106D02%
	2 or 5 digits	03	 %1106D03%
Truncation/Expansion 1107	None	00*	 %1107D00% *
	Truncate leading zeros	01	 %1107D01%
	Expand to EAN-13	02	 %1107D02%
	Truncate system character	03	 %1107D03%
	Add country code	04	 %1107D04%
Ink Spreading Canceling 1108	Disable	00*	 %1108D00% *
	Enable	01	 %1108D01%



%%END END

3-8 UPC-E

Read:

Format

System character "0"	Data digits (6 digits)	Check digits
----------------------	------------------------	--------------

Check digit verification: The check digit verification is optional.

Check digit trans.: By setting Enable, check digit will be transmitted.

Code ID setting: Refer to Code ID setting of [3-7 UPC-A](#).

Insert group selection: Refer to Insert group selection of [3-7 UPC-A](#).

Supplement digits:

Format

System character "0"	Data digits (6 digits)	Check digit	Supplement digits 2 or 5
----------------------	------------------------	-------------	--------------------------

Truncation/Expansion:

Truncate leading zeros - Refer to Truncation/Expansion of [3-7 UPC-A](#).

Expand to EAN-13 - It extends to 13-digits with "0" digits when the feature is set to be enabled.

Example: Barcode "01236547", Output: "0012360000057".

Expand to UPC-A - It extends to 12-digits when the feature is set to be enabled.

Example: Barcode "01236547",

Output: "012360000057".

Truncate system character - The system character "0" of UPC-E data can be truncated when this feature is enabled.

Add country code - The country code ("0" for USA) can be added when the feature is enabled.



%SETUP

SETUP

Multiple-scan setting			Single-scan setting
Option barcode	Option	Alpha. value	
Read 1201	Disable	00	 %1201D00%
	Enable	01*	 %1201D01% *
Check digit verification 1202	Disable	00	 %1202D00%
	Enable	01*	 %1202D01% *
Check digit trans. 1203	Disable	00	 %1203D00%
	Enable	01*	 %1203D01% *



SETUP

Multiple-scan setting			Single-scan setting
Option barcode	Option	Alpha. value	
Code ID setting 1204	00-FF ₁₆ (ASCII)	00-FF ₁₆	
		<D>*	%1204H44% *
Insert group selection 1205	00-44 (00: None)	00-44	
		00*	%1205D00% *
Supplement digits 1206	None	00*	%1206D00% *
	2 digits	01	%1206D01%
	5 digits	02	%1206D02%
	2 or 5 digits	03	%1206D03%
Truncation/Expansion 1207	None	00*	%1207D00% *
	Truncate leading zeros	01	%1207D01%
	Expand to EAN-13	02	%1207D02%
	Expand to UPC-A	03	%1207D03%
	Truncate system character	04	%1207D04%
	Add country code	05	%1207D05%



END

3-9 UPC-E1

Read:

Format

System character "1"	Data digits (6 digits)	Check digits
----------------------	------------------------	--------------

Check digit verification: The check digit verification is optional.

Check digit trans.: By setting Enable, check digit will be transmitted.

Code ID setting: Refer to

Code ID setting

 of [3-7 UPC-A](#).

Insert group selection: Refer to

Insert group selection

 of [3-7 UPC-A](#).

Supplement digits:

Format

System character "1"	Data digits (6 digits)	Check digit	Supplement digits 2 or 5
----------------------	------------------------	-------------	--------------------------

Truncation/Expansion:

Expand to EAN-13 - It extends to 13-digits with "0" digits when the feature is set to be enabled.

Example: Barcode "11236597", Output: "0112365000097".

Expand to UPC-A - It extends to 12-digits when the feature is set to be enabled.

Example: Barcode "11236597", Output: "112365000097".

Truncate system character - The system character "1" of UPC-E1 data can be truncated when the feature is enabled.















Add country code - The country code ("0" for USA) can be added when the feature is enabled.



Multiple-scan setting			Single-scan setting
Option barcode	Option	Alpha. value	
Read 3401	Disable	00	
	Enable	01*	
Check digit verification 3402	Disable	00	
	Enable	01*	
Check digit trans. 3403	Disable	00	
	Enable	01*	



%SETUP SETUP

Multiple-scan setting			Single-scan setting
Option barcode	Option	Alpha. value	
Code ID setting  3404	00-FF ₁₆ (ASCII)	00-FF ₁₆	
		<D>*	 %3404H44% *
Insert group selection  3405	00-44 (00: None)	00-44	
		00*	 %3405D00% *
Supplement digits  3406	None	00*	 %3406D00% *
	2 digits	01	 %3406D01%
	5 digits	02	 %3406D02%
	2 or 5 digits	03	 %3406D03%
Truncation/Expansion  3407	None	00*	 %3407D00% *
	Expand to EAN-13	02	 %3407D02%
	Expand to UPC-A	03	 %3407D03%
	Truncate system character	04	 %3407D04%
	Add country code	05	 %3407D05%



%%END END

3-10 EAN-13 (ISBN/ISSN)

Read:

Format

Data digits (12 digits)	Check digit
-------------------------	-------------

Check digit verification: The check digit verification is optional.

Check digit transmission: By setting Enable, check digit will be transmitted.

EAN-13 code ID setting: Refer to Code ID setting of [3-7 UPC-A](#).

Insert group selection: Refer to Insert group selection of [3-7 UPC-A](#).

Supplement digits:

Format

Data digits (12 digits)	Check digit	Supplement digits 2 or 5
-------------------------	-------------	--------------------------

ISBN/ISSN conversion: The ISBN (International Standard Book Number) and ISSN (International Standard Serial Number) are two kinds of barcode for books and magazines. The ISBN is 10 digits with leading “978” and the ISSN is 8 digits with leading “977” of the EAN-13 symbol.







Example:

Barcode “9780194315104”, Output: “019431510X”.

Barcode “9771005180004”, Output: “10051805”.

Ink Spreading Canceling: If enabled, the scanner can more easily read the EAN-13 barcode printed with ink spreading. But it may cause the scanner to decode some well-printed EAN-13 barcode wrongly. Please ask the advice from the support engineer of the manufacturer before applying this function.





















ISBN/ISSN code ID setting: Refer to Code ID setting of [3-7 UPC-A](#).

 %SETUP SETUP			
Multiple-scan setting			Single-scan setting
Option barcode	Option	Alpha. value	
Read  1301	Disable	00	 %1301D00%
	Enable	01*	 %1301D01% *
Check digit verification  1302	Disable	00	 %1302D00%
	Enable	01*	 %1302D01% *



%SETUP

SETUP

Multiple-scan setting			Single-scan setting
Option barcode	Option	Alpha. value	
Check digit transmission  1303	Disable	00	 %1303D00%
	Enable	01*	 %1303D01% *
EAN-13 code ID setting  1304	00-FF ₁₆ (ASCII)	00-FF ₁₆	
		<A>*	 %1304H41% *
Insert group selection  1305	00-44 (00: None)	00-44	
		00*	 %1305D00% *
Supplement digits  1306	None	00*	 %1306D00% *
	2 digits	01	 %1306D01%
	5 digits	02	 %1306D02%
	2 or 5 digits	03	 %1306D03%
ISBN/ISSN conversion  1307	Disable	00*	 %1307D00% *
	Enable	01	 %1307D01%
Ink Spreading Canceling  1308	Disable	00*	 %1308D00% *
	Enable	01	 %1308D01%
ISBN/ISSN code ID setting  1309	00-FF ₁₆ (ASCII)	00-FF ₁₆	
		*	 %1309H42% *



%%%END

END

3-11 EAN-8

Read:

Format

Data digits (7 digits)	Check digit
------------------------	-------------

Check digit verification: The check digit verification is optional.

Check digit trans.: By setting Enable, check digit will be transmitted.

Code ID setting: Refer to

Code ID setting

 of *3-7 UPC-A*.

Insert group selection: Refer to

Insert group selection

 of *3-7 UPC-A*.

Supplement digits:

Format

Data digits (7 digits)	Check digit	Supplement Digits 2 or 5
------------------------	-------------	--------------------------

Truncation/Expansion: Refer to

Truncation/Expansion

 of *3-7 UPC-A*.



%SETUP

SETUP

Multiple-scan setting			Single-scan setting
Option barcode	Option	Alpha. value	
Read 1401	Disable	00	 %1401D00%
	Enable	01*	 %1401D01% *
Check digit verification 1402	Disable	00	 %1402D00%
	Enable	01*	 %1402D01% *
Check digit trans. 1403	Disable	00	 %1403D00%
	Enable	01*	 %1403D01% *
Code ID setting 1404	00-FF ₁₆ (ASCII)	00-FF ₁₆	
		<C>*	 %1404H43% *
Insert group selection 1405	00-44 (00: None)	00-44	
		00*	 %1405D00% *
Supplement digits 1406	None	00*	 %1406D00% *
	2 digits	01	 %1406D01%
	5 digits	02	 %1406D02%
	2 or 5 digits	03	 %1406D03%
Truncation/Expansion 1407	None	00*	 %1407D00% *
	Truncate leading zero	01	 %1407D01%
	Expand to EAN-13	02	 %1407D02%



%%%END

END

3-12 Code 39 (Code 32, Trioptic Code 39)

Read:

Format

Start character(*)	Data digits (variable)	Check digit (optional)	End character(*)
--------------------	------------------------	------------------------	------------------

Check digit verification: The check digit verification is optional.

Check digit transmission: By setting Enable, check digit will be transmitted.

Max./Min. code length: Each symbol has own max./min. code length. If both setting of max./min. code length are "00"s, the setting of global max./min. code length is effective. The length is defined as to the actual barcode data length to be sent. Label with length exceeds these limits will be rejected. Make sure that the minimum length setting is no greater than the maximum length setting, otherwise all the labels of the symbol will not be readable. In particular, you can see the same value for both minimum and maximum reading length to force the fixed length barcode decoded. Refer to [3-5 Scan trigger mode & some global settings](#).

Code ID setting: Refer to

Code ID setting

 of [3-7 UPC-A](#).

Insert group selection: Refer to

Insert group selection

 of [3-7 UPC-A](#).

Start/End transmission: The start character and end character of Code 39 are "*"s. You can transmit all data digits including two "*"s.

"*" as data character: By setting Enable, "*" can be recognized as data character.

Convert Code 39 to Code 32: Code 32 is a variant of Code 39 used by the Italian pharmaceutical industry. Note that Code 39 must be enabled in order for this parameter to function.

Format of Code 32

"A" (optional)	Data digits (8 digits)	Check digit
----------------	------------------------	-------------

Code 32 Prefix "A" transmission: By setting Enable, the prefix character "A" can be added to all Code 32 barcodes.

Trioptic Code 39 read: Trioptic Code 39 is a variant of Code 39 used in the marking of magnetic tapes and computer cartridges. Trioptic Code 39 symbols always contain six characters.

Format of Trioptic Code 39

Start character (\$)	Data digits (6 digits)	End character (\$)
----------------------	------------------------	--------------------

Trioptic Code 39 Start/End transmission: The start character and end character of Trioptic Code 39 are "\$"s. You can transmit all data digits including two "\$"s.



%SETUP

SETUP

Multiple-scan setting			Single-scan setting
Option barcode	Option	Alpha. value	
Read 1501	Disable	00	
	Enable	01*	*
Check digit verification 1502	Disable	00*	*
	Enable	01	
Check digit transmission 1503	Disable	00*	*
	Enable	01	
Max. code length 1504	00-99	00-99	
		99*	*
Min. code length 1505	00-99	00-99	
		01*	*
Code ID setting 1506	00-FF ₁₆ (ASCII)	00-FF ₁₆	
		<M>*	*
Insert group selection 1507	00-44 (00: None)	00-44	
		00*	*
Format 1508	Standard	00*	*
	Full ASCII	01	
Start/End transmission 1509	Disable	00*	*
	Enable	01	



%SETUP

SETUP

Multiple-scan setting			Single-scan setting
Option barcode	Option	Alpha. value	
"*" as data character  1510	Disable	00*	 %1510D00% *
	Enable	01	 %1510D01%
Convert Code 39 to Code 32  1511	Disable	00*	 %1511D00% *
	Enable	01	 %1511D01%
Code 32 Prefix "A" transmission  1512	Disable	00*	 %1512D00% *
	Enable	01	 %1512D01%
Trioptic Code 39 read  1513	Disable	00*	 %1513D00% *
	Enable	01	 %1513D01%
Trioptic Code 39 Start/End transmission  1514	Disable	00*	 %1514D00% *
	Enable	01	 %1514D01%



%%%END

END

Note 1: If Trioptic Code 39 is set Enable, Code 39 is forced Enable.

Note 2: If Code 39 is set Disable, Trioptic Code 39 is forced Disable.

3-13 Interleaved 2 of 5

Read:

Format

Data digits (variable)	Check digit (optional)
------------------------	------------------------

Check digit verification: The check digit verification is optional.

Check digit transmission: By setting Enable, check digit will be transmitted.

Max./Min. code length: Refer to

Max./Min. code length

 of [3-12 Code 39](#).

Code ID setting: Refer to

Code ID setting

 of [3-7 UPC-A](#).

Insert group selection: Refer to

Insert group selection

 of [3-7 UPC-A](#).



%SETUP

SETUP

Multiple-scan setting			Single-scan setting
Option barcode	Option	Alpha. value	
Read  1601	Disable	00	 %1601D00%
	Enable	01*	 %1601D01% *
Check digit verification  1602	Disable	00*	 %1602D00% *
	USS	01	 %1602D01%
	OPCC	02	 %1602D02%
Check digit transmission  1603	Disable	00*	 %1603D00% *
	Enable	01	 %1603D01%
Max. code length  1604	00-99	00-99	
		99*	 %1604D99% *
Min. code length  1605	00-99	00-99	
		06*	 %1605D06% *
Code ID setting  1606	00-FF ₁₆ (ASCII)	00-FF ₁₆	
		< >*	 %1606H49% *
Insert group selection  1607	00-44 (00: None)	00-44	
		00*	 %1607D00% *



%%END

END

3-14 Industrial 2 of 5

Read:

Format

Data digits (variable)

Check digit transmission: By setting Enable, check digit will be transmitted.

Max./Min. code length: Refer to Max./Min. code length of *3-12 Code 39*.

Code ID setting: Refer to Code ID setting of *3-7 UPC-A*.

Insert group selection: Refer to Insert group selection of *3-7 UPC-A*.

Multiple-scan setting			Single-scan setting
Option barcode	Option	Alpha. value	
Read  1701	Disable	00*	 %1701D00% *
	Enable	01	 %1701D01%
Max. code length  1702	00-99	00-99	
		99*	 %1702D99% *
Min. code length  1703	00-99	00-99	
		04*	 %1703D04% *
Code ID setting  1704	00-FF ₁₆ (ASCII)	00-FF ₁₆	
		<H>*	 %1704H48% *
Insert group selection  1705	00-44 (00: None)	00-44	
		00*	 %1705D00% *

 %%%END END

3-15 Matrix 2 of 5

Read:

Format

Data digits (variable)	Check digit (optional)
------------------------	------------------------

Check digit verification: The check digit verification is optional.

Check digit transmission: By setting Enable, check digit will be transmitted.

Max./Min. code length: Refer to

Max./Min. code length

 of [3-12 Code 39](#).

Code ID setting: Refer to

Code ID setting

 of [3-7 UPC-A](#).

Insert group selection: Refer to

Insert group selection

 of [3-7 UPC-A](#).



%SETUP

SETUP

Multiple-scan setting			Single-scan setting
Option barcode	Option	Alpha. value	
Read  1801	Disable	00	 %1801D00%
	Enable	01*	 %1801D01% *
Check digit verification  1802	Disable	00*	 %1802D00% *
	Enable	01	 %1802D01%
Check digit transmission  1803	Disable	00*	 %1803D00% *
	Enable	01	 %1803D01%
Max. code length  1804	00-99	00-99	
		99*	 %1804D99% *
Min. code length  1805	00-99	00-99	
		06*	 %1805D06% *
Code ID setting  1806	00-FF ₁₆ (ASCII)	00-FF ₁₆	
		<X>*	 %1806H58% *
Insert group selection  1807	00-44 (00: None)	00-44	
		00*	 %1807D00% *



%%%END

END

3-16 Codabar

Read:

Format

Start character	Data digits (variable)	Check digit (optional)	End character
-----------------	------------------------	------------------------	---------------

Check digit verification: The check digit verification is optional.

Check digit transmission: By setting Enable, check digit will be transmitted.

Max./Min. code length: Refer to **Max./Min. code length** of [3-12 Code 39](#).

Code ID setting: Refer to **Code ID setting** of [3-7 UPC-A](#).

Insert group selection: Refer to **Insert group selection** of [3-7 UPC-A](#).

Start/End type: Codabar has four pairs of Start/End pattern; you may select one pair to match your application.

Start/End transmission: By setting Enable, the start and end character of a Codabar barcode will be transmitted.

Start/End character equality: By setting Enable, the start and end character of a Codabar barcode must be the same.



















%SETUP SETUP

Multiple-scan setting			Single-scan setting
Option barcode	Option	Alpha. value	
Read 1901	Disable	00	
	Enable	01*	*
Check digit verification 1902	Disable	00*	*
	Enable	01	
Check digit transmission 1903	Disable	00*	*
	Enable	01	
Max. code length 1904	00-99	00-99	
		99*	*



%SETUP

SETUP

Multiple-scan setting			Single-scan setting
Option barcode	Option	Alpha. value	
Min. code length  1905	00-99	00-99	
		04*	 %1905D04% *
Code ID setting  1906	00-FF ₁₆ (ASCII)	00-FF ₁₆	
		<N>*	 %1906H4E% *
Insert group selection  1907	00-44 (00: None)	00-44	
		00*	 %1907D00% *
Start/End type  1908	ABCD/ABCD	00*	 %1908D00% *
	abcd/abcd	01	 %1908D01%
	ABCD/TN*E	02	 %1908D02%
	abcd/tn*e	03	 %1908D03%
Start/End transmission  1909	Disable	00*	 %1909D00% *
	Enable	01	 %1909D01%
Start/End character equality  1910	Disable	00*	 %1910D00% *
	Enable	01	 %1910D01%



%%%END

END

3-17 Code 128

Read:

Format

Data digits (variable)	Check digit (optional)
------------------------	------------------------

Check digit verification: The check digit verification is optional.

Check digit transmission: By setting Enable, check digit will be transmitted.

Max./Min. code length: Refer to

Max./Min. code length

 of [3-12 Code 39](#).

Code ID setting: Refer to

Code ID setting

 of [3-7 UPC-A](#).

Insert group selection: Refer to

Insert group selection

 of [3-7 UPC-A](#).

Truncate leading zeros: The leading “0” digits or all “0” digits of Code 128 barcode characters can be truncated when the feature is enabled.



%SETUP

SETUP

Multiple-scan setting			Single-scan setting
Option barcode	Option	Alpha. value	
Read 2001	Disable	00	
	Enable	01*	*
Check digit verification 2002	Disable	00	
	Enable	01*	*
Check digit transmission 2003	Disable	00*	*
	Reserved	01	
Max. code length 2004	00-99	00-99	
		99*	*
Min. code length 2005	00-99	00-99	
		01*	*
Code ID setting 2006	00-FF ₁₆ (ASCII)	00-FF ₁₆	
		<K>*	*
Insert group selection 2007	00-44 (00: None)	00-44	
		00*	*
Truncate leading zeros 2008	Disable	00*	*
	All leading "0"s	01	
	Only the first "0"	02	



%%END

END

3-18 UCC/EAN 128 (GS1-128)

Read:

Format

Data digits (variable)	Check digit (optional)
------------------------	------------------------

Check digit verification: The check digit verification is optional.

Check digit transmission: By setting Enable, check digit will be transmitted.

Max. /Min. code length: Refer to [Max. /Min. code length](#) of [3-12 Code 39](#).

Code ID setting: Refer to [Code ID setting](#) of [3-7 UPC-A](#).

Insert group selection: Refer to [Insert group selection](#) of [3-7 UPC-A](#).

Truncate leading zeros: The leading “0” digits or all “0” digits of UCC/EAN 128 barcode characters can be truncated when the feature is enabled.



%SETUP

SETUP

Multiple-scan setting			Single-scan setting
Option barcode	Option	Alpha. value	
Read 2501	Disable	00	
	Enable	01*	*
Check digit verification 2502	Disable	00	
	Enable	01*	*
Check digit transmission 2503	Disable	00*	*
	Reserved	01	
Max. code length 2504	00-99	00-99	
		99*	*
Min. code length 2505	00-99	00-99	
		01*	*
Code ID setting 2506	00-FF ₁₆ (ASCII)	00-FF ₁₆	
		<K>*	*
Insert group selection 2507	00-44 (00: None)	00-44	
		00*	*
Truncate leading zeros 2508	Disable	00*	*
	All leading "0"s	01	
	Only the first "0"	02	



%%%END

END

3-19 ISBT 128

Read:

Format

Start character(“=” or “&”)	Data digits (variable)	Check digit (optional)
-----------------------------	------------------------	------------------------

Check digit verification: The check digit verification is optional.

Check digit transmission: By setting Enable, check digit will be transmitted.

Max./Min. code length: Refer to

Max./Min. code length

 of [3-12 Code 39](#).

Code ID setting: Refer to

Code ID setting

 of [3-7 UPC-A](#).

Insert group selection: Refer to

Insert group selection

 of [3-7 UPC-A](#).



%SETUP

SETUP

Multiple-scan setting			Single-scan setting
Option barcode	Option	Alpha. value	
Read 3301	Disable	00	
	Enable	01*	*
Check digit verification 3302	Disable	00	
	Enable	01*	*
Check digit transmission 3303	Disable	00*	*
	Reserved	01	
Max. code length 3304	00-99	00-99	
		99*	*
Min. code length 3305	00-99	00-99	
		01*	*
Code ID setting 3306	00-FF ₁₆ (ASCII)	00-FF ₁₆	
		<K>*	*
Insert group selection 3307	00-44 (00: None)	00-44	
		00*	*



%%END

END

3-20 Code 93

Read:

Format

Data digits (variable)	2 check digits (optional)
------------------------	---------------------------

Check digit verification: The check digit verification is optional.

Check digit transmission: By setting Enable, check digit will be transmitted.

Max./Min. code length: Refer to

Max./Min. code length

 of [3-12 Code 39](#).

Code ID setting: Refer to

Code ID setting

 of [3-7 UPC-A](#).

Insert group selection: Refer to

Insert group selection

 of [3-7 UPC-A](#).



%SETUP

SETUP

Multiple-scan setting			Single-scan setting
Option barcode	Option	Alpha. value	
Read  2101	Disable	00	 %2101D00%
	Enable	01*	 %2101D01% *
Check digit verification  2102	Disable	00	 %2102D00%
	Enable	01*	 %2102D01% *
Check digit transmission  2103	Disable	00*	 %2103D00% *
	Enable	01	 %2103D01%
Max. code length  2104	00-99	00-99	
		99*	 %2104D99% *
Min. code length  2105	00-99	00-99	
		01*	 %2105D01% *
Code ID setting  2106	00-FF ₁₆ (ASCII)	00-FF ₁₆	
		<L>*	 %2106H4C% *
Insert group selection  2107	00-44 (00: None)	00-44	
		00*	 %2107D00% *



%%%END

END

3-21 Code 11

Read:

Format

Data digits (variable)	1 or 2 check digits (optional)
------------------------	--------------------------------

Check digit verification: The check digit verification is optional.

Check digit transmission: By setting Enable, 1 or 2 check digits will be transmitted upon the selected check digit verification method.

Max./Min. code length: Refer to

Max./Min. code length

 of [3-12 Code 39](#).

Code ID setting: Refer to

Code ID setting

 of [3-7 UPC-A](#).

Insert group selection: Refer to



Insert group selection

 of [3-7 UPC-A](#).



%SETUP

SETUP

Multiple-scan setting			Single-scan setting
Option barcode	Option	Alpha. value	
Read  2201	Disable	00*	 *
	Enable	01	
Check digit verification  2202	Disable	00	
	One digit	01*	 *
	Two digits	02	
Check digit transmission  2203	Disable	00*	 *
	Enable	01	
Max. code length  2204	00-99	00-99	
		99*	 *
Min. code length  2205	00-99	00-99	
		04*	 *
Code ID setting  2206	00-FF ₁₆ (ASCII)	00-FF ₁₆	
		<V>*	 *
Insert group selection  2207	00-44 (00: None)	00-44	
		00*	 *



%%%END

END

3-22 MSI/Plessey

Read:

Format

Data digits (variable)	1 or 2 check digits (optional)
------------------------	--------------------------------

Check digit verification: The MSI/Plessey has one or two optional check digits. There are three methods to verify check digits, i.e. Mod10, Mod10/10 and Mod 11/10. 1 or 2 check digits will be calculated as the sum module 10 or 11 of the data digits.

Check digit transmission: By setting Enable, 1 or 2 check digits will be transmitted upon the selected check digit verification method.

Max./Min. code length: Refer to

Max./Min. code length

 of [3-12 Code 39](#).

Code ID setting: Refer to

Code ID setting

 of [3-7 UPC-A](#).

Insert group selection: Refer to

Insert group selection

 of [3-7 UPC-A](#).



%SETUP

SETUP

Multiple-scan setting			Single-scan setting
Option barcode	Option	Alpha. value	
Read  2301	Disable	00*	 * %2301D00%
	Enable	01	 * %2301D01%
Check digit verification  2302	Disable	00*	 * %2302D00%
	1 digit (Mod 10)	01	 * %2302D01%
	2 digits (Mod 10/10)	02	 * %2302D02%
	2 digits (Mod 11/10)	03	 * %2302D03%
Check digit transmission  2303	Disable	00*	 * %2303D00%
	Enable	01	 * %2303D01%
Max. code length  2304	00-99	00-99	
		99*	 * %2304D99%
Min. code length  2305	00-99	00-99	
		04*	 * %2305D04%
Code ID setting  2306	00-FF ₁₆ (ASCII)	00-FF ₁₆	
		<O>*	 * %2306H4F%
Insert group selection  2307	00-44 (00: None)	00-44	
		00*	 * %2307D00%



%%END

END

3-23 UK/Plessey

Read:

Format

Data digits (variable)	2 check digits (optional)
------------------------	---------------------------

Check digit verification: The UK/Plessey has two optional check digits. The check digit 1 and check digit 2 will be calculated as the sum module 10 or 11 of the data digits.

Check digit transmission: By setting Enable, check digit will be transmitted.

Max./Min. code length: Refer to

Max./Min. code length

 of [3-12 Code 39](#).

Code ID setting: Refer to

Code ID setting

 of [3-7 UPC-A](#).

















Insert group selection: Refer to

Insert group selection

 of [3-7 UPC-A](#).



%SETUP SETUP

Multiple-scan setting			Single-scan setting
Option barcode	Option	Alpha. value	
Read  2401	Disable	00	 %2401D00%
	Enable	01*	 %2401D01% *
Check digit verification  2402	Disable	00	 %2402D00%
	Enable	01*	 %2402D01% *
Check digit transmission  2403	Disable	00*	 %2403D00% *
	Enable	01	 %2403D01%
Max. code length  2404	00-99	00-99	
		99*	 %2404D99% *
Min. code length  2405	00-99	00-99	
		01*	 %2405D01% *
Code ID setting  2406	00-FF ₁₆ (ASCII)	00-FF ₁₆	
		<U>*	 %2406H55% *
Insert group selection  2407	00-44 (00: None)	00-44	
		00*	 %2407D00% *



%%END END

3-24 China Post

Read:

Format

11 Data digits

Max. /Min. code length: Refer to Max. /Min. code length of [3-12 Code 39](#). The code length of China Post is 11.

Code ID setting: Refer to Code ID setting of [3-7 UPC-A](#).

Insert group selection: Refer to Insert group selection of [3-7 UPC-A](#).

Multiple-scan setting			Single-scan setting
Option barcode	Option	Alpha. value	
Read  2601	Disable	00	 %2601D00%
	Enable	01*	 %2601D01% *
Max. code length  2604	00-99	00-99	
		11*	 %2604D11% *
Min. code length  2605	00-99	00-99	
		11*	 %2605D11% *
Code ID setting  2606	00-FF ₁₆ (ASCII)	00-FF ₁₆	
		<T>*	 %2606H54% *
Insert group selection  2607	00-44 (00: None)	00-44	
		00*	 %2607D00% *

%%END END

3-25 Telepen

Read:

Format

Start character (_)	Data digits (variable)	Check digit	End character (z)
-----------------------	------------------------	-------------	---------------------

Check digit verification: The check digit verification is optional.

Check digit transmission: By setting Enable, check digit will be transmitted.

Max./Min. code length: Refer to

Max./Min. code length

 of [3-12 Code 39](#).

Code ID setting: Refer to

Code ID setting

 of [3-7 UPC-A](#).

Insertion group selection: Refer to

Insertion group selection

 of [3-7 UPC-A](#).

Encode character set type: Two options. Same Telepen symbol, with different option, is associated with different data output.

Alphanumeric- Supports both letters and numbers within the data source.

Numeric- Supports only numbers within the data source and ignores all letters.



%SETUP

SETUP

Multiple-scan setting			Single-scan setting
Option barcode	Option	Alpha. entry	
Read  3501	Disable	00	 %3501D00%
	Enable	01*	 %3501D01% *
Check digit verification  3502	Disable	00	 %3502D00%
	Enable	01*	 %3502D01% *
Check digit transmission  3503	Disable	00*	 %3503D00% *
	Enable	01	 %3503D01%
Max. code length  3504	00-99	00-99	
		00*	 %3504D00% *
Min. code length  3505	00-99	00-99	
		01*	 %3505D01% *
Code ID setting  3506	00-FF ₁₆	00-FF ₁₆	
		<P>*	 %3506H50% *
Insertion group selection  3507	00-66	00-66	
		00*	 %3507D00% *
Encode character set type  3508	Alphanumeric	00*	 %3508D00% *
	Numeric	01	 %3508D01%



%%%END

END

3-26 GS1 DataBar (GS1 DataBar Truncated)

GS1 DataBar Truncated is structured and encoded as the same as the standard GS1 DataBar format, except its height is reduced to a 13 modules minimum; while GS1 DataBar should have a height greater than or equal to 33 modules.

Read:

Format

16 Data digits





Code ID setting: Refer to **Code ID setting** of [3-7 UPC-A](#).

Insert group selection: Refer to **Insert group selection** of [3-7 UPC-A](#).

Conversion:

UCC/EAN 128- Refer to **Code ID transmission** of [3-31 String transmission](#),]Cm will be identified as AIM ID.

UPC-A or EAN-13- Barcode beginning with a single zero as the first digit has the leading “010” stripped and the barcode reported as EAN-13. Barcode beginning with two or more zeros but not six zeros has the leading “0100” stripped and the barcode reported as UPC-A.

Multiple-scan setting			Single-scan setting
Option barcode	Option	Alpha. value	
Read  2701	Disable	00	 %2701D00%
	Enable	01*	 %2701D01% *
Code ID setting  2702	00-FF ₁₆ (ASCII)	00-FF ₁₆	
		<R>*	 %2702H52% *
Insert group selection  2703	00-44 (00: None)	00-44	
		00*	 %2703D00% *
Conversion  2704	None	00*	 %2704D00% *
	UCC/EAN 128	01	 %2704D01%
	UPC-A or EAN-13	02	 %2704D02%

%%END END

3-27 GS1 DataBar Limited

Read:

Format

16 Data digits

Code ID setting: Refer to Code ID setting of [3-7 UPC-A](#).

Insert group selection: Refer to Insert group selection of [3-7 UPC-A](#).

Conversion: Refer to Conversion of [3-26 GS1 DataBar \(GS1 DataBar Truncated\)](#).

Multiple-scan setting			Single-scan setting
Option barcode	Option	Alpha. value	
 2801	Disable	00	 %2801D00%
	Enable	01*	 %2801D01% *
 2802	00-FF ₁₆ (ASCII)	00-FF ₁₆	
		<R>*	 %2802H52% *
 2803	00-44 (00: None)	00-44	
		00*	 %2803D00% *
 2804	None	00*	 %2804D00% *
	UCC/EAN 128	01	 %2804D01%
	UPC-A or EAN-13	02	 %2804D02%

 %%%END END

3-28 GS1 DataBar Expanded

Read:

Format

Data characters (variable)

Code ID setting: Refer to Code ID setting of [3-7 UPC-A](#).

Insert group selection: Refer to Insert group selection of [3-7 UPC-A](#).

Conversion:

UCC/EAN 128- Refer to Code ID transmission of [3-31 String transmission](#),]Cm will be identified as AIM ID.



%SETUP SETUP

Multiple-scan setting			Single-scan setting
Option bar code	Option	Alpha. value	
Read 2901	Disable	00	 %2901D00%
	Enable	01*	 %2901D01% *
Max. code length 2902	00-99	00-99	
		99*	 %2902D99% *
Min. code length 2903	00-99	00-99	
		01*	 %2903D01% *
Code ID setting 2904	00-FF ₁₆ (ASCII)	00-FF ₁₆	
		<R>*	 %2904H52% *
Insert group selection 2905	00-44 (00: None)	00-44	
		00*	 %2905D00% *
Conversion 2906	None	00*	 %2906D00% *
	UCC/EAN 128	01	 %2906D01%



%%%END END

3-29 G1-G4 & FN1 substitution string setting

Format of barcode data transmission:

Prefix	Code name	Preamble	Code ID	Code length	Code data	Code ID	Postamble	Suffix
--------	-----------	----------	---------	-------------	-----------	---------	-----------	--------

Suffix string setting: The <enter> key is represented in different ASCII when it is applied by different OS. For a Windows/DOS OS, <enter> is represented as <CR><LF> (0x0D 0x0A); for an Apple MAC OS, <enter> is represented as <CR> (0x0D); for a Linux/Unix OS, <enter> is represented as <LF> (0x0A).

Prefix/Suffix/Preamble/Postamble string setting:

They are appended to the data automatically when a barcode is decoded.

Example: Add a symbol of "\$" as a prefix for all type of barcode.

Steps:

- 1) Look up in the ASCII table to find the value of \$→24.
- 2) Scan **SETUP** and **Prefix string setting** barcode.
- 3) Scan **2** and **4** barcode.
- 4) Scan **END** barcode.
- 5) Refer to [3-31 String transmission](#), set **Prefix transmission** to be Enable.

Scanning steps: Scan the following barcodes in order.



Insert G1/G2/G3/G4 string setting: The scanner offers 4 positions and 4 character strings to insert among the barcode data string.

Example: Set G1 string to be "AB".

Original code data	"1 2 3 4 5 6"
Output code data	"1 2 A B 3 4 5 6"

Steps:

- 1) Look up in the ASCII table to find the value of A→41, B→42.
- 2) Scan **SETUP** and **Insert G1 string setting** barcode "8005".
- 3) Scan **4**, **1** and **4**, **2** barcode.
- 4) Scan **END** barcode.
- 5) Refer to [3-30 G1-G4 string position & Code ID position](#).
- 6) Refer to [3-5 Scan trigger & some global settings](#).

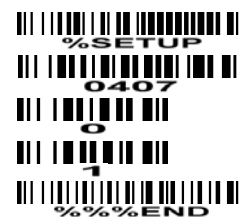
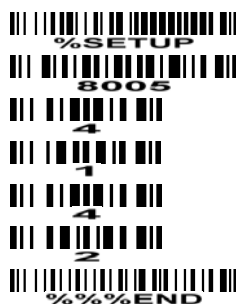

Testing barcode:



FN1 substitution string setting: The FN1 character (0x1D) in an UCC/EAN128 barcode, or a Code 128 barcode, or a GS1 DataBar barcode can be substituted with a defined string.

Example: Set FN1 substitution string to be “ABCD”.

Original code data (hexadecimal)	“31 1D 32 1D 33 1D 34 1D 35”
Output code data (hexadecimal)	“31 41 32 42 33 43 34 44 35”

Steps:

- 1) Set FN1 substitution string to be ABCD.
- 2) Refer to [3-31 String transmission](#), enable FN1 substitution transmission.

In this example, because the interface of the scanner is RS232, so set “8209” to 02.

Scanning steps: Scan the following barcodes in order.

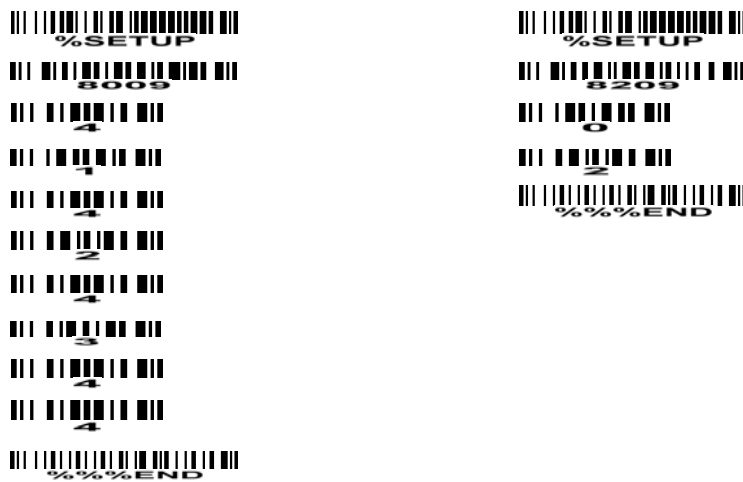







Testing barcode:





%SETUP

SETUP

Multiple-scan setting			Single-scan setting
Option bar code	Option	Alpha. value	
Prefix string setting  8001	0-22 characters (Default: None)	00-FF ₁₆	
Suffix string setting  8002	0-22 characters	00-FF ₁₆	
	<ENTER>	0D0A*	
Preamble string setting  8003	0-22 characters (Default: None)	00-FF ₁₆	
Postamble string setting  8004	0-22 characters (Default: None)	00-FF ₁₆	
Insert G1 string setting  8005	0-22 characters (Default: None)	00-FF ₁₆	
Insert G2 string setting  8006	0-22 characters (Default: None)	00-FF ₁₆	
Insert G3 string setting  8007	0-22 characters (Default: None)	00-FF ₁₆	
Insert G4 string setting  8008	0-22 characters (Default: None)	00-FF ₁₆	
FN1 substitution string setting  8009	0-4 characters	00-FF ₁₆	
	<SP>	20*	 %8009H20% *



%%%END

END













3-30 G1-G4 string position & Code ID position

Format of barcode data transmission:

Prefix	Code name	Preamble	Code ID	Code length	Code data	Code ID	Postamble	Suffix
--------	-----------	----------	---------	-------------	-----------	---------	-----------	--------

Insert G1/G2/G3/G4 string position: The scanner offers 4 positions to insert strings among the symbol. In case of the insertion position is greater than the length of the symbol, the insertion of string is not effective.

Code ID position: It is allowed to select different positions of code ID placement.

 %SETUP SETUP			
Multiple-scan setting			Single-scan setting
Option bar code	Option	Alpha. value	
Insert G1 string position  8101	00-99	00-99	
		00*	 *
Insert G2 string position  8102	00-99	00-99	
		00*	 *
Insert G3 string position  8103	00-99	00-99	
		00*	 *
Insert G4 string position  8104	00-99	00-99	
		00*	 *
Code ID position  8105	Before code data	00*	 *
	After code data	01	 *
 %%%END END			

3-31 String transmission

Format of barcode data transmission:

Prefix	Code name	Preamble	Code ID	Code length	Code data	Code ID	Postamble	Suffix
--------	-----------	----------	---------	-------------	-----------	---------	-----------	--------

Prefix transmission: By setting Enable, prefix will be appended before the data transmitted.

Suffix transmission: By setting Enable, suffix will be appended after the data is transmitted.

Code name transmission: By setting Enable, code name will be transmitted before code data.

Preamble transmission: By setting Enable, preamble will be appended before the data transmitted.

Postamble transmission: By setting Enable, postamble will be appended after the data is transmitted.













Code ID transmission: Code ID can be transmitted in the format of either Proprietary ID or AIM ID.

Refer to [1-2 Default settings for various types of barcode](#).





















Code length transmission: The length of code data string can be transmitted before the code data when Enable is selected. The length is represented by a number with two digits.

Case conversion: The characters within code data or the whole output string can be set in either upper case or lower case.

FN1 substitution transmission: The scanner supports a FN1 substitution feature for keyboard wedge, USB and RS-232 interface. The replacement string of FN1 can be chosen by user (see [3-29 G1-G4 & FN1 substitution string setting](#)).

Multiple-scan setting			Single-scan setting
Option bar code	Option	Alpha. value	
Prefix transmission  8201	Disable	00*	 * %8201D00%
	Enable	01	 %8201D01%
Suffix transmission  8202	Disable	00	 %8202D00%
	Enable	01*	 * %8202D01%
Code name transmission  8203	Disable	00*	 * %8203D00%
	Enable	01	 %8203D01%
Preamble transmission  8204	Disable	00*	 * %8204D00%
	Enable	01	 %8204D01%

 %SETUP SETUP

Multiple-scan setting			Single-scan setting
Option bar code	Option	Alpha. value	
Postamble transmission  8205	Disable	00*	 *
	Enable	01	
Code ID transmission  8206	Disable	00*	 *
	Proprietary ID	01	
	AIM ID	02	
Code length transmission  8207	Disable	00*	 *
	Enable	01	
Case conversion  8208	Disable	00*	 *
	Upper (data only)	01	
	Lower (data only)	02	
	Upper (whole string)	03	
	Lower (whole string)	04	
FN1 substitution transmission  8209	Disable	00*	 *
	USB	01	
	RS232	02	
	USB/RS232	03	

 %%%END END

4 Barcode representing non-printable character

Notes to make the following barcode:

1. According to different barcode printing software, the method of printing following barcode is different.
2. If using CODESOFT software, firstly read the information through “Help→Index→Code128→Special input syntax”. For example, if we wish to make “F1” barcode, select “code128”, then select “CODE A” type, and input “{DOC1}” as data.



5 ASCII table

		for keyboard wedge		for RS-232	
L \ H	0	1	0	1	
	0	Null		NUL	DLE
1	Up	F1	SOH	DC1	
2	Down	F2	STX	DC2	
3	Left	F3	ETX	DC3	
4	Right	F4	EOT	DC4	
5	PgUp	F5	ENQ	NAK	
6	PgDn	F6	ACK	SYN	
7		F7	BEL	ETB	
8	Bs	F8	BS	CAN	
9	Tab	F9	HT	EM	
A		F10	LF	SUB	
B	Home	Esc	VT	ESC	
C	End	F11	FF	FS	
D	Enter	F12	CR	GS	
E	Insert	Ctrl+	SO	RS	
F	Delete	Alt+	SI	US	

Notes: The 2nd and the 3rd columns above are used for keyboard wedge only.

L \ H	2	3	4	5	6	7
0	SP	0	@	P	`	p
1	!	1	A	Q	a	q
2	“	2	B	R	b	r
3	#	3	C	S	c	s
4	\$	4	D	T	d	t
5	%	5	E	U	e	u
6	&	6	F	V	f	v
7	‘	7	G	W	g	w
8	(8	H	X	h	x
9)	9	I	Y	i	y
A	*	:	J	Z	j	z
B	+	;	K	[k	{
C	,	<	L	\	l	
D	-	=	M]	m	}
E	.	>	N	^	n	~
F	/	?	O	_	o	DEL

Example: ASCII “A” = “41”.

6 Test chart

UPC-A
6 59871 23231 9
UPC-E
0 232310 7
UPC-E1
1 6 5 4 3 2 1 4
EAN-13
1 234567 891019
ISBN/ISSN
9 780194 315104
EAN-8
0123 4510
Code 39
0189-.\$AZ
Code 32
A908765439
Trioptic Code 39 (Default setting: Disable)
\$123456\$
Interleaved 2 of 5
0123456789
Industrial 2 of 5 (Default setting: Disable)
0123456789
Matrix 2 of 5
9876543210
Codabar
a01+-.:\$89a

Test chart (continue)

Code 128



01AZ[+*/]za98

UCC/EAN 128



01AZ[]+az54

ISBT 128



=1234 56789

Code 93



01AZ+/*az89

Code 11

(Default setting: Disable)



123456789-0

MSI/Plessey

(Default setting: Disable)



0123456789

UK/Plessey



01ABEF89

China Post



54789632145

Telepen



_1234567z

GS1 DataBar (GS1 DataBar Truncated)



(01) 12345678901231

GS1 DataBar Limited



(01) 09876543210128

GS1 DataBar Expanded



Ab_09+yZ

7 Return default parameters & firmware version



WARNING: Restore factory defaults

If you wish to return the scanner to all the factory default settings, scan the barcode above. But Scanning mode remains unchanged.



Write to customer defaults

Write current parameter settings to the customer default settings. But Scanning mode remains unchanged.



Restore customer defaults

Restore the customer default settings to current settings. If failed, restore the factory default settings. But Scanning mode remains unchanged.



Firmware version list

If you wish to display the firmware version, scan the barcode above. If the interface is RS232 or USB virtual COM, and Decode data format is set to packet, the firmware version will be packet and transmitted.

8 Quick setting to enable/ disable Auto-detection

Note: Auto-detection is an optional accessory.



Enable Auto-detection

If you wish to enable Auto-detection, scan the barcode above.



Disable Auto-detection

If you wish to disable Auto-detection, scan the barcode above. Note: The Scanning mode will switch to momentary.

9 Configuration alphanumeric value barcode (as Para. value)



To finish parameter setting, please scan the bar code below.

